

- Standard Input Current 0.1-80A
- Frequency 50Hz — 400Hz
- Standard accuracy 0.5,1
- Operating Temp. -40°C to +70°C
- ANSI C57.13 and IEC60044-1 Standards



Electrical Specifications @ 25°C

P/N	Input Current (A)	Available Outputs		Insulation Voltage
		Current (mA)	Voltage (V)	
PECS10-15	15	20, 33.3, 40, 50, 100, 1000	0.25, 0.333, 0.5, 1.0, 2.0	4000
PECS10-30	30			4000
PECS10-50	50			4000
PECS10-60	60			4000
PECS10-75	75			4000

Mechanical Dimensions: (mm)

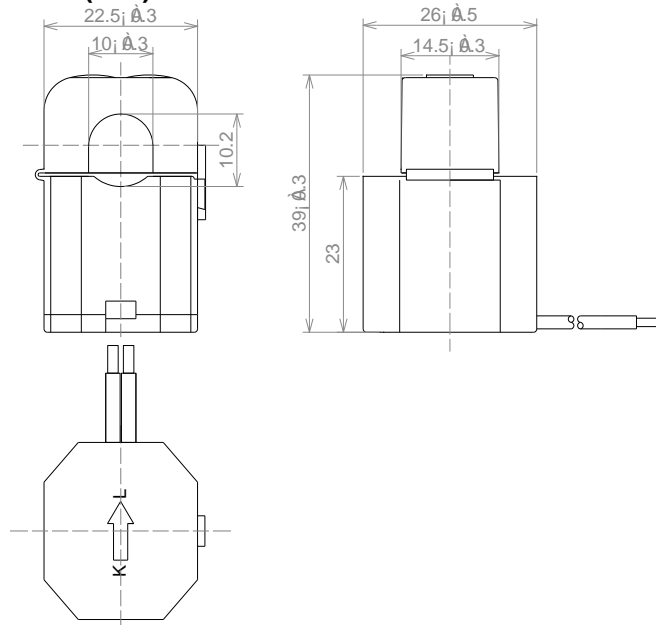

Schematic

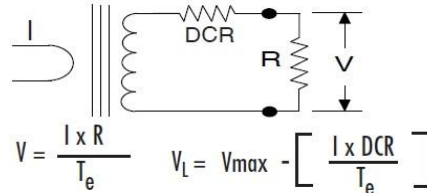

Note: Before installation, safety precautions must be followed by licensed professional. Never energize primary unless short circuited terminals or burden connected to secondary.

PRODUCT P/N: PECS10-XX

REV: 00-09/13/17

TUSTIN OFFICE:

15991 Red Hill Avenue, Suite #102, Tustin, California 92780 USA

Tel:+1-714-460-0718 Fax:+1-714-460-0728

<http://www.palnova.com>

Milpitas OFFICE:

500 Yosemite Drive, Milpitas, CA. 95035 USA

Tel:+1-408-855-8866 Fax:+1-408-855-8868